



SWIFT. SILENT. SECURE.



Blade™

**PRO II
SERIES**

SPORTSMAN II

INSTALLATION & OWNER GUIDE

Powered by



C-MONSTER®
CONTROL SYSTEM 2.0

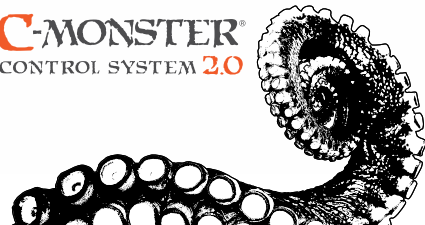

Welcome to the world of Power-Pole[®],
the original shallow water anchor.



POWER-POLE[®]
SHALLOW WATER ANCHOR

SWIFT. SILENT. SECURE.

Congratulations on your purchase of a Power-Pole® shallow water anchor featuring C-Monster Control System. It has been designed, engineered, and manufactured to provide the best possible performance and dependability. Please read all installation instructions carefully.

The information contained here describes the proper procedures for safely installing your Power-Pole shallow water anchor. If you have questions, contact our Technical Support Team at **1+ (813) 689-9932 option 2** or visit our website at **www.power-pole.com**.

INSTALLATION

INSTALLATION TOOLS

- 1/2", 9/16", 5/8" wrenches
- 1/2" & 9/16" sockets with ratchet
- drill
- 7/64", 9/64", 3/4", 5/16" drill bits
- #2 Phillips-head bit or screwdriver
- Heat gun
- 4' straight edge
- Marine grade sealant
- Fine point marker
- Tape measure
- Wire cutters
- Wire strippers
- Wire terminal crimpers
- Small funnel

INSTALLATION HARDWARE

- A Qty(4) 5/16" x 3.5" all-thread transom mount bolts
- B Qty(4) 5/16" neo-bond washers
- C Qty(4) 5/16" fender washers
- D Qty(4) 5/16" tall brass nuts
- E Qty(2) 3/8" x 3/4" bolts
- F Qty(2) 3/8" neo-bond washers
- G Qty(2) #8 x 3/4" flat head screws (included with Dash Switch)
- H Qty(4) #10 x 3/4" pan head screws
- I Qty(1) rubber pump gasket
- J Qty(2) ring terminal connectors
- K Qty(2) thru-hull bushings (pre-installed on tubing)
- L Qty(1) adhesive strip (included with Dash Switch)

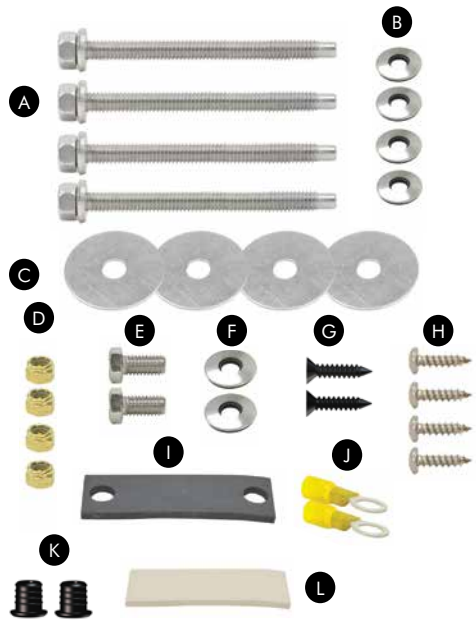

CAUTION:

Do not use the Power-Pole shallow water anchor as your primary anchor. Never leave your boat unattended while anchored solely with the Power-Pole shallow water anchor.

STEP 1 Choose A Mounting Location

Adapter Plate Mounting

1. Follow the instructions included with your Power-Pole adapter plate. If you do not have an adapter plate, please contact one of our authorized dealers or visit www.power-pole.com and click on "Accessories > Find My Adapter Plate". For technical support call **1+ (813) 689-9932 option 2**.

Transom Mounting

VERTICAL POSITIONING

1. Place a straight edge on the bottom of the hull directly below and centered from the desired mounting location. The lowest point of the Power-Pole anchor must be at least 4" above this straight edge or the vessel may experience adverse handling effects. **FIG. 1**

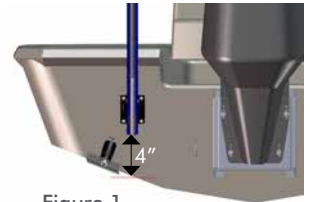

Figure 1

NOTE: If the vessel is equipped with trim tabs that measure 9" or less in length, the standard 4" minimum mounting height will be sufficient. If the trim tabs are larger than 9", the Power-Pole anchor will need to be mounted higher up on the transom to prevent interference.

2. While holding the Power-Pole anchor in place, turn and tilt the motor as far as possible toward the unit. With the motor turned toward the unit, manually move the anchor through its entire range of motion to verify clearance.
3. Once clearance has been verified on the exterior portion of the vessel, check for adequate space on the inside of the transom mounting area. Make sure that the bolts will not have any obstructions and that you will have space to tighten the 5/16" tall brass nuts **D**.

STEP 2 Mounting The Anchor

1. Place the stern bracket against the transom, and mark the mounting holes with a fine point marker.

NOTE: If installing 8' Blade shallow water anchor re-route hydraulic hose through the stern bracket side outlets, with one hose out of each side. See Step 4

FIG. 6

2. Carefully drill pilot holes in each of the four marked locations with a 9/64" drill bit. Then, drill out each of the four pilot holes with a 5/16" drill bit.
3. Apply a liberal amount of marine grade sealant between the stern bracket and the hull, as well as around the 5/16" holes.
4. With a 1/2" wrench and 1/2" socket, fasten the stern bracket to the transom using the (4) 5/16" x 3.5" all-thread transom mount bolts **A**, (4) 5/16" neo-bond washers **B**, (4) 5/16" fender washers **C**, and (4) 5/16" tall brass nuts **D**. The rubber backed neo-bond washers **B** will protect the powder coated surface of the stern bracket and they must not be over tightened. **FIG. 2** Neo-bond washers **B** are not needed for 10' Blade.

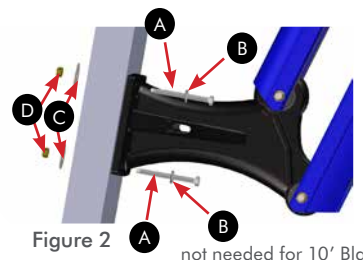

Figure 2

not needed for 10' Blade



Figure 3

10' Blade only

IMPORTANT: Unit must be through bolted to transom.

NOTE: If installing 10' Blade install the shroud ensuring not to over tighten the screws. **FIG. 3** (screws included with shroud.)

STEP 3 Installing The Hydraulic Pump Unit (HPU)

1. Locate a dry compartment in the vessel with ample space to accommodate the HPU. The footprint of the HPU is approximately 6.5"x 7".

NOTE: Be sure to allow enough clearance surrounding the HPU to install the (2) 3/8" x 3/4" bolts **E** through the mounting bracket and into the HPU. **FIG. 5**

2. Remove the fill cap on the HPU and fill the reservoir to the "full" line with the supplied quart of Green Marine® biodegradable hydraulic fluid.

WARNING: Using anything other than an ISO 32 hydraulic fluid, such as Green Marine, may cause damage to the HPU.

3. Place the HPU bracket in the predetermined area of the vessel and mark the (4) mounting hole locations with a fine point marker.

WARNING: Before drilling holes to mount the HPU mounting bracket, inspect the area beneath the mounting surface to ensure that the drill bit will not cause any damage.

4. Drill a hole into each of the marked hole locations with a 9/64" drill bit.

5. Fasten the bracket to the vessel using a #2 Phillips-head screwdriver and the (4) #10 x 3/4" pan head screws **H**. **FIG. 4**

6. Once the bracket is securely fastened, use a 9/16" wrench to attach the HPU to its bracket using the (2) 3/8" x 3/4" bolts **E**, (2) 3/8" neo-bond washers **F**, and (1) rubber pump gasket **I**. **FIG. 5**

7. Route the red wire to a 12 Volt positive source via a battery switch to prevent power draw when not in use.

8. Route the black wire to the 12 Volt negative common ground post.

9. Install the (2) ring terminal connectors **J** using wire strippers and wire terminal crimpers.

10. Heat the (2) ring terminal connectors **J** with a heat gun until their respective jackets shrink completely and adhere to the wires.

WARNING: DO NOT CONNECT the red or black wire to the battery at this time. These wires will be connected once the hydraulic hose is installed.

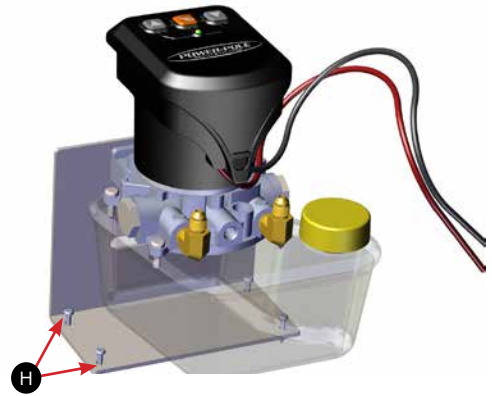

Figure 4

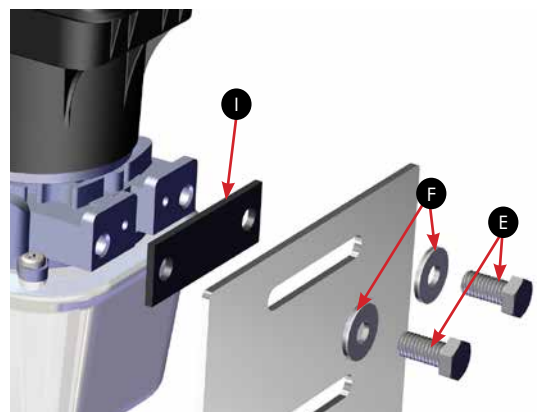

Figure 5

STEP 4 Installing The Hydraulic Hose

WARNING: Keep debris out of the hydraulic hose. Do not remove blue plastic from the end of hydraulic hose while routing throughout the boat. Debris in the hose will cause damage to the HPU.

- The hydraulic hose may be routed either over the transom or through the transom. **FIG. 6-11.** If the hydraulic hose is not being installed through the transom, route the hose to the HPU and proceed to Step 4 below.

NOTE: If installing a Blade 8' anchor, DO NOT route both hydraulic hoses through one side of the stern bracket.

IMPORTANT: Be sure to allow an adequate amount of slack in the hydraulic hose between the stern bracket and the point that the hose enters the vessel. This will provide for full up and down operation.

- Mark two 3/4" holes on the transom above the water line for bushings (K) spaced 1-1/4" apart. Then, drill a pilot hole in the middle of each marked hole with a 5/16" drill bit. Next, drill pilot holes out with a 3/4" drill bit, route hydraulic hoses to HPU through transom holes and install thru-hull bushings (K). **FIG. 12 & 13**

IMPORTANT: Put a small amount of marine sealant around bushings (K) before installing into the boat transom.

NOTE: Thru-hull bushings (K) can be removed from hydraulic hoses if thru-hull bushings (K) are not being used.

- Remove the blue and black dust caps from the hydraulic fittings on the HPU.
- Remove the "Insert Up Hose Here Tag" and finger tighten the hose labeled "Up" and then turn fitting a quarter turn using a 5/8" wrench. **FIG. 14-17.** Repeat this step for the DOWN hose.

OVER THE TRANSOM

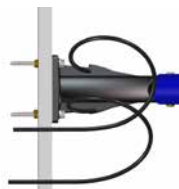

Figure 6
BLADE 8'



Figure 7
PRO II & SPORTSMAN



Figure 8
BLADE 10'

THROUGH THE TRANSOM

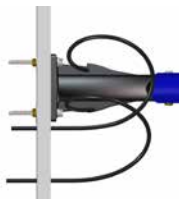

Figure 9
BLADE 8'



Figure 10
PRO II & SPORTSMAN



Figure 11
BLADE 10'

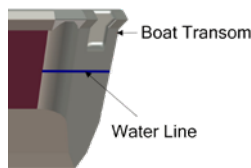

Figure 12

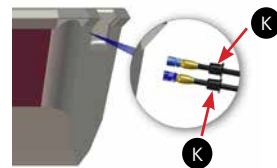

Figure 13



Figure 14



Figure 15



Figure 16

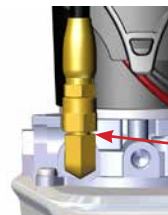

Figure 17

Preferred amount of space

STEP 5 Priming The HPU

1. Connect the red fuse holder ring terminal to the main battery cut-off switch and the black ring terminal to negative common ground post. The HPU will make a charge audio ID tune and the LED indicator light will begin flashing **GREEN**. **FIG. 18**
2. Manually, lower the anchor to the deployed position.
3. Use the dash remote and change to the slowest speed. See Operation section to change speed settings.
4. Hold Down button until the **RED** LED on the dash remote stops flashing and the pump stops running. (Approximately 20 sec.) Repeat, twice. **NOTE:** The HPU will have a high pitch whining sound while priming until the air has dissipated from hydraulic fluid.
5. Check the fluid level in the reservoir and add if necessary.
6. Hold the UP button until the **RED** LED on the dash remote stops flashing and the pump stops running. (Approximately 20 sec.) Repeat this process two more times or until the Power-Pole anchor is fully retracted.
7. Repeat steps 4 & 6 once.
8. Change dash remote to medium speed setting.
9. Repeat steps 4 & 6 once.
10. With the anchor in the stowed position, push on the anchor to test the prime. If the anchor does not stay fully retracted when manually forced to deploy, then repeat the priming steps.
11. Once on the water, navigate to water deep enough to fully deploy the anchor without touching the bottom and retract the anchor six times, to finish the priming process.
12. Your Power-Pole anchor should be completely primed at this point, but if you suspect it isn't, repeat step 11 until it is or contact JL Marine System's Inc. for **Technical Support at 813-689-9932 Option 2.**



Figure 18

STEP 6 Programming Dual Units

NOTE: Each Power-Pole anchor is preprogrammed as a single unit. When using only one anchor do not program as a port or starboard.

1. Determine which HPU controls the starboard side Power-Pole anchor using the UP & DOWN buttons on both HPUs. **FIG. 19**
2. Locate the C-Monster PROGRAM button on the top of the starboard HPU. Depress and hold it for 6 seconds until the LED flashes **RED** and 2 chimes are heard followed by a single beep. **FIG. 20**
3. Next, depress and release the UP button. The LED will flash **RED** 1 time with a single beep indicating that the HPU has been assigned as the starboard side unit. Press and release the PROGRAM button to save and exit. The LED will flash **RED** 1 time with a single beep followed by 2 consecutive beeps.
4. On the port side HPU, repeat Step 2 to enter programming mode. Next, depress and release the DOWN button on the HPU. The LED will flash **RED** twice with 2 consecutive beeps indicating that the programming has been completed successfully and the HPU has been assigned as the port side unit. Press and release the PROGRAM button to save and exit. The LED will flash **RED** 2 times with a double beep followed by 2 consecutive beeps.

NOTE: For additional menu settings please refer to the Operation Section.



Figure 19



Figure 20

STEP 7 Pairing Dual Units To A Single Wireless Controller

NOTE: Each Power-Pole anchor comes paired to the included Dash Switch and Key Fob remotes. When installing dual anchors, you can program a single Dash Switch and/or Key Fob remote to control both units as follows:

1. Determine which HPU is paired with the controller by pressing the UP or DOWN button on the controller.
2. Press and hold the PROGRAM button on the other HPU for 3 seconds until the LED turns **GREEN** and a single beep is heard.
3. Press and release either the UP or DOWN button on the controller until the unit responds. **FIG. 21**

IMPORTANT: The first time your remote is paired to a recently-updated pump it may perform a firmware update. When this occurs the remote will blink for approximately 1 minute. Please do not interrupt power to either the pump or remote during this process. When the blinking has ceased your remote has finished updating and is ready to use.

NOTE: The pump will not update an unpaired remote.



Figure 21

STEP 8 Installing The Advanced Dash Switch

1. Locate a suitable area with a flat surface to mount the Dash Switch and mark the hole location with a fine point marker.
2. Carefully drill the marked hole locations with a 7/64" drill bit to fasten the switch using the (2) flat head screws **G** supplied (do not over tighten). Or you may choose to install using the supplied adhesive strip **L** (not shown).



OPERATION



Here you'll find information on all of the functions, safe use, and proper maintenance of your shallow water anchor. If you have questions, contact our Technical Support Team at **1 + (813) 689-9932 option 2** or visit our website at **www.power-pole.com**.

HPU (Hydraulic Pump Unit) Using Top Side Control Functions

Powered by  **C-MONSTER**
CONTROL SYSTEM 2.0



HPU INDICATOR LIGHT GUIDE

LIGHT	INDICATION
Flashing GREEN Light 	NORMAL: System has proper voltage (11.9V – 16.4V).
Flashing ORANGE Light 	LOW: System has low voltage (10.8V – 11.8V).
Flashing RED Light 	WARNING: System has low voltage (10.7V or less). NOTE: When voltage is below 6V or above 16.5V the unit will not operate.

FUNCTION 1: Setting As A Single, Port/Starboard Unit (Duals)

1. Depress and hold the C-Monster PROGRAM button for 6 seconds until LED flashes **RED** and 2 chimes are heard followed by a single beep.

- To set as a single HPU: Press and hold both UP and DOWN buttons simultaneously.
- To set as starboard side HPU: Press and release the UP button.
- To set as port side HPU: Press and release the DOWN button.

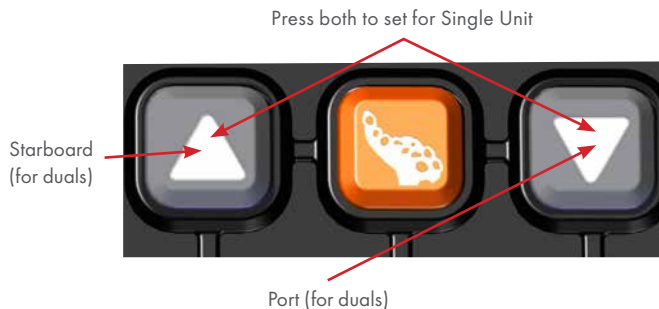

2. Once you have made all desired setting changes, press and release the PROGRAM button to save your settings and exit program mode. You will hear a series of beeps and the LED will return to flashing **GREEN**.



FUNCTION 2: Key-Fob Speed Adjustment

NOTE: Default settings are set to 70% of the highest speed level. Tone increases with level (1-10). **FIG. 1**

1. Depress and hold the C-Monster PROGRAM button for 6 seconds until LED flashes **RED** and 2 chimes are heard followed by two beeps.
2. Press the UP button for higher speed setting and DOWN button for lower speed setting. **FIG. 1**

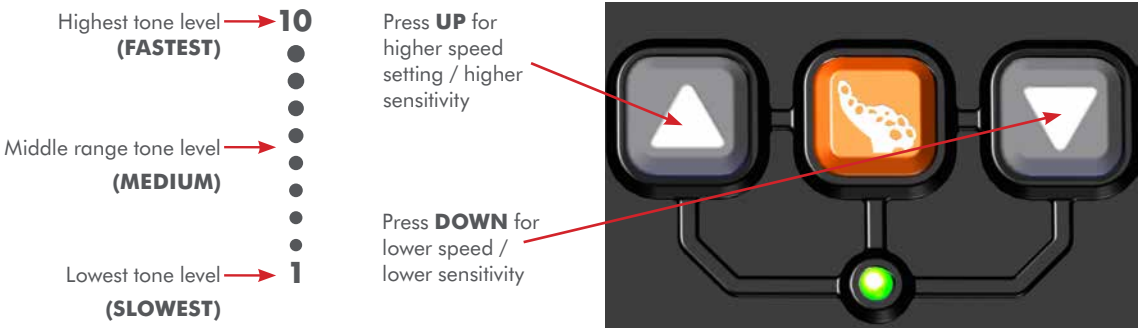

Figure 1

3. Once you have made all desired setting changes, press and release the PROGRAM button to save your settings and exit program mode. You will hear a series of beeps and the LED will return to flashing **GREEN**.

FUNCTION 3: Up Sensitivity Adjustment

Controls the operation of the Auto Up feature. If the unit continues to run once retracted, increase the sensitivity. If the unit stops running prematurely, decrease the sensitivity.

NOTE: Default settings are in the middle of the range. Tone increases with level (1-10). **FIG. 1**

1. Depress and hold the PROGRAM button for 6 seconds until LED flashes **RED** and 2 chimes are heard followed by 3 beeps.
2. Press the UP for higher sensitivity setting and DOWN for lower sensitivity setting. **FIG. 1**
3. Once you have made all desired setting changes, press and release the PROGRAM button to save your settings and exit program mode. You will hear a series of beeps and LED will return flashing **GREEN**.

FUNCTION 4: Down Sensitivity Adjustment

Controls the operation of the Auto DOWN feature. If the unit turns off prematurely during deployment, decrease the sensitivity. If the unit continues to run once anchored, increase the sensitivity.

NOTE: Default settings are in the middle of the range. Tone increases with level (1-10). **FIG. 1**

1. Depress and hold the PROGRAM button for 6 seconds until LED flashes **RED** and 2 chimes are heard followed by 4 beeps.
2. Press the UP for higher sensitivity setting and DOWN for lower sensitivity setting. **FIG. 1**
3. Once you have made all desired setting changes, press and release the PROGRAM button to save your settings and exit the program mode. You will hear a series of beeps and LED return flashing **GREEN**.



Advanced Dash Switch Remote Control

DEPLOYMENT OPTIONS

To raise or lower your Power-Pole anchor, press and hold either the UP or DOWN button. The anchor will only continue to move as long as you press the button.

AUTO MODE (DASH SWITCH)

Double tapping (pressing and releasing 2 times within 1 second) either the UP or the DOWN button on the Dash Switch will cause the anchor to retract or deploy automatically. The anchor will continue to move in said direction until it either retracts completely (Auto Up) or senses a solid bottom surface (Auto Down).

NOTE: Auto mode can be changed to a single tap via the C-Monster App.

SPEED CONTROL

The Dash Switch has 3 speed settings (slow, medium, and fast). Pressing and releasing the Speed Control button will toggle through the 3 settings. The LED lights will flash at a speed that corresponds to either a slow, medium, or fast setting.

MULTIPLE ANCHORS

With multiple Power-Pole anchors, the Dash Switch can be used to toggle between independent or simultaneous control of the anchors. Depressing and releasing the Directional Control button will toggle through the multiple anchors. The LED lights will flash corresponding to either left, right, or both to indicate the current control settings.

Standard Key Fob Remote Control

DEPLOYMENT OPTIONS

To raise or lower the Power-Pole anchor, press and hold either the UP or DOWN button. The anchor will only continue to move as long as you press the button.

AUTO MODE (KEY FOB)

Double tapping (pressing and releasing 2 times within 1 second) either the UP or DOWN button on the Key Fob will cause the anchor to retract or deploy automatically. The anchor will continue to move in said direction until it either retracts completely (Auto Up) or senses a solid bottom surface (Auto Down).

NOTE: Auto mode can be changed to a single tap via the C-Monster App.



Speed Control



Directional Control
(Port, Starboard,
or Both selections)



C-MONSTER

Wireless Controller Battery Replacement Instructions



IMPORTANT: Ensure the switch and the surrounding area is as dry as possible to avoid any moisture intrusion before changing battery in controller.

Advanced Dash Switch

STEP 1

Remove the (2) #8 x 3/4" flat head screws from the top of dash switch.

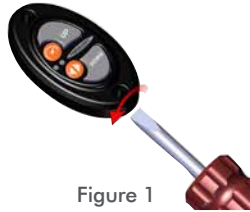

Figure 1

STEP 2

Use a small slotted screwdriver to remove the dash switch cover plate. **FIG. 1**

STEP 3

Remove the rubber switch membrane and the board from the dash switch base.

STEP 4

Remove the battery from the holder on the back of the board and replace with any CR2032 3V Lithium Coin Battery.

STEP 5

Place the board and rubber switch membrane back into the dash switch base and ensure that the rubber switch membrane is seated properly prior to installing the cover plate. **FIG. 2**

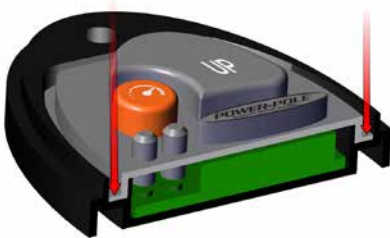

Figure 2

Standard Key Fob Remote

STEP 1

Use a small slotted screwdriver to remove the key fob cover. **FIG. 1**

STEP 2

Remove the rubber membrane and the circuit board from Key Fob base.

STEP 3

Remove the battery from the holder on the front of circuit board and replace with any CR2032 3V Lithium Coin Battery. **FIG. 2**

STEP 4

Place the circuit board and rubber membrane back into the Key Fob base and ensure that the rubber membrane is seated properly prior to installing the cover. **FIG. 3**



Figure 1



Figure 2



Figure 3

C-MONSTER

Smart Phone App



The C-Monster App is available for free from Google Play and the Apple App Store. The C-Monster App allows you to do the following:

- **Configure settings for custom operation.** Take full control of everything from deployment speed to independent or synchronized control of multiple anchors. Not to mention Auto Up/Auto Down and bottom sensing.
- **Troubleshoot with AMP streaming instant diagnosis.** The information is sent directly to the Power-Pole Technical Support Team so we can instantly see what's happening and you can count on little or no down time.
- **Check signal strength of all your remotes with RSSI evaluation.** This allows you to instantly see if your signal is weak or if any other devices are disrupting your signal.
- **Update software.** You will receive automatic prompts to update your C-Monster software if a new version is available.
- **Quick product registration.** Now you can easily register your Power-Pole anchors and accessories directly through the app.
- **Theft recovery.** Once you register your Power-Pole anchor with the C-Monster App, if it's ever stolen we can help law enforcement track and recover it.



DOWNLOAD
THE C-MONSTER APP @



MAINTENANCE and Storage

- Inspect all hydraulic lines for kinking or abrasion prior to use.
 - Inspect all hydraulic fittings for leaks and proper tightness prior to each use.
- CAUTION:** If disconnecting the hydraulic lines, please read the following:
Hydraulic lines are always pressurized and disconnecting them will cause a sudden high pressure release. This high pressure release may cause oil leakage from the lines and/or fittings. When depressurizing the lines the unit must be supported otherwise the anchor will fall to the fully deployed position. This may result in damage to the unit as well as bodily harm.
- Inspect all electrical connections to ensure that they are secure and free of corrosion every 3 months.
 - Inspect all fasteners for proper tightness after every 100 cycles to ensure that the Power-Pole anchor is in safe working condition.

NOTE: Tighten the 2 lower stern bracket lock nuts snug and all other lock nuts flush with the end of bolt with no threads showing to reduce noise or vibration.

FIG. 1 & 2

IMPORTANT: The stern bracket hinge bolts on the 10' Blade model do not require retightening.

- Ensure that the Green Marine® biodegradable hydraulic fluid level is within the indicator marks on the reservoir at all times.



Figure 1



Figure 2



- Thoroughly rinse all moving parts with fresh water after each use.
- Lubricate the bushings at both the stern bracket and knuckle hinge points with spray lithium grease every 6 months. **FIG. 3 & 4**

NOTE: Lithium grease application does not apply to stern bracket on 10' Blade.

Figure 3

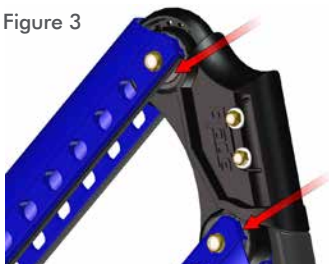
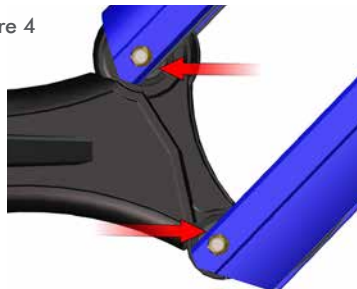

Figure 4



PRECAUTIONS

- Prior to use, read this guide carefully. Become familiar with the controls and how to operate your Power-Pole shallow water anchor properly.
- Do not allow children to operate or tamper with the Power-Pole shallow water anchor without adult supervision.
- Do not modify the unit in any way.
- Use only genuine Power-Pole shallow water anchor accessories.
- Always disconnect the 12 Volt power source from the anchor before servicing.
- In the event of HPU failure, your Power-Pole anchor may be manually stowed by activating the pole protector valve.
 - Do so by applying enough upward force to lift the unit into its upright position.
 - If the anchor is not within reach, you may drive the boat toward shallow water. This will apply enough upward force to lift the unit within reach.
- Be sure to have your Power-Pole anchor in the stowed (fully upright) position while operating your vessel at high speeds.
- Always maintain a safe distance between the anchor and your extremities. Avoid wearing loose clothing within close proximity of the anchor; failure to do so may result in bodily injury.
- Do not use your Power-Pole shallow water anchor as a form of assistance for entering or exiting the vessel.
- Never leave your boat unattended with the Power-Pole anchor as the primary anchorage.
- During situations with high wind or rough seas, your Power-Pole anchor may release holding pressure in order to protect your vessel's transom.
- If any debris gets caught around your Power-Pole anchor, disconnect the 12 Volt power source prior to removal.
- Always ensure that your Power-Pole shallow water anchor is in the stowed position when traveling.

FAQ

Frequently Asked Questions



For Technical Support, please call 1+(813) 689-9932 option 2.

Q: Can my dual Power-Pole anchors be controlled independently?

A: Yes. The C-Monster Control system allows for the independent control of dual Power-Pole anchors. The included Advanced C-Monster Dash Switch is capable of independent control, but the included Standard Key Fob is not.

Q: What maintenance is required with my Power-Pole shallow water anchor?

A: The lower pivot bolts on your Power-Pole anchor need to be checked every 100 cycles and tightened as needed. Should you see any damaged bushings upon tightening, replace them immediately.

NOTE: This is not required for 10' Blade models 2017 and later.

Q: How often should I change my hydraulic fluid?

A: While there is no recommended time interval for a hydraulic fluid flush, the fluid should be changed if there is any visible debris in the reservoir. Additionally, if the fluid appears milky or white it should be changed immediately; white fluid is a sign of water intrusion and the entire system should be checked for leaks.

Q: What type of hydraulic fluid should I use?

A: The HPU reservoir should be filled with Green Marine® biodegradable hydraulic fluid or an ISO 32 hydraulic fluid. Green Marine is available through all authorized Power-Pole dealers.

Q: Are Power-Pole HPUs interchangeable?

A: No. All Power-Pole HPUs, while identical in appearance, are unique in regard to the pressures that they produce. Certain anchor models require more pressure due to their size, while other anchors are set with higher pressures in order to enhance performance. Aside from HPU pressures, all C-Monster units have an internal circuit board containing firmware that is specific to each model.

Q: How will the Power-Pole affect my battery during operation?

A: The average life of a 12 Volt battery with 55 cold cranking amps is 1,200 cycles per charge.

Q: Will the C-Monster HPU drain my battery when it is not in use?

A: No. Although the HPU should be powered off via a battery switch when stored, the amperage draw on your vessel's battery is a negligible 21 mA. You may set your Power-Pole HPU to enter Hibernation Mode after a set time of rest via the C-Monster app. In this mode, the HPU will only draw (6 mA).

Q: Do I need two HPUs in order to run dual Power-Poles?

A: Yes. We recommend the use of an independent pump system with each Power-Pole anchor for the following reasons:

- Dual Power-Pole anchors will not deploy at the same time and/or same rate using 1 pump.
- The relief valves will not function according to the intended design of the Power-Pole anchor and may cause a mechanical failure when using only 1 pump system.
- Many features of our newer models will not be functional when a single pump is used.
- Damage is possible using 1 pump with 2 Power-Pole anchors and doing so will void all warranties.

Q: What should I do if my Power-Pole anchor is stuck in the deployed position?

A: If your Power-Pole anchor will not retract for any reason, simply drive toward shallow water and the pole protector valve will allow the anchor to stow.

Q: How many wireless controllers can I program to my C-Monster System?

A: Up to ten (10) wireless controllers can be programmed to operate your single or dual Power-Pole anchors.



Q: How do I program a new wireless controller to my existing C-Monster system?

- A: 1. Press and hold the PROGRAM button on top of the (HPU) hydraulic pump unit for 3 seconds until the LED turns solid **GREEN** (HPU will also beep).
2. Press and hold either the UP or DOWN button on the wireless controller you are pairing until the unit responds.

IMPORTANT: The first time your remote is paired to a recently-updated pump it may perform a firmware update. When this occurs the remote will blink for approximately 1 minute. Please do not interrupt power to either the pump or remote during this process. When the blinking has ceased your remote has finished updating and is ready to use.

NOTE: The pump will not update an unpaired remote.

Q: How do I adjust the speed on my included wireless Key Fob remote?

A: The included Key Fob remote comes out of the box set to 70% of the highest speed level. This can be adjusted by downloading the C-Monster App and connecting to the system via Bluetooth with your Android powered smart phone or Apple iPhone. For manual adjustment, see Function 2 Key-Fob Speed Adjustment.

Q: How do I order a replacement spike?

A: Replacement spikes can only be ordered via phone. Simply call a member of our Technical Support Team at **1+(813) 689-9932 option 2** for a free replacement. Before calling please be sure that you have your serial number. Serial numbers are located on the bottom of the stern bracket on most models.

Q: Why does my Power-Pole anchor fall down over time?

A: This is caused by either an external or internal leak in the hydraulic system. First, check all hydraulic fittings and hose for leaks. If no external leaks are found, please contact our Technical Support Team.

Q: What are JL Marine System's hours of operation?

A: Business hours, including Technical Support hours, are listed at www.power-pole.com.



SWIFT. SILENT. SECURE.

LIMITED Warranty



To find a Certified Warranty Center, visit www.power-pole.com.

Five (5) Year Limited Warranty — Power-Pole Blade and PRO II Shallow Water Anchor

Three (3) Year Limited Warranty — Power-Pole Sportsman II Shallow Water Anchor

Conditions of this Warranty

A Power-Pole shallow water anchor manufactured by JL Marine systems Inc. is warranted against defects in material and workmanship in the stern bracket, knuckle joint, U-channel, hydraulic system, and electrical system to the original end consumer from the original purchase date according to the following stipulations:

1. Power-Pole shallow water anchor warranties are activated when product is registered online at www.power-pole.com/register or by using the C-Monster smart phone app or upon receipt by JL Marine Systems, Inc. of a completed warranty card, postdated within (10) days of the original purchase date. Please retain your sales receipt as proof of purchase.
2. Install Genuine Power-Pole Merchandise ONLY. This warranty is void if any non authorized parts are used or installed.
3. This warranty is void if the Power-Pole shallow water anchor is used commercially, structurally altered, or subject to stress beyond the physical limits of the manufactured material.
4. This warranty does not cover abrasion or abnormal abuse, nor does it cover the Power-Pole shallow water anchor for anything other than its intended use.
5. JL Marine Systems, Inc. reserves the right to change products and designs without incurring any obligations to incorporate such changes in already completed products, or those in the hands of dealers or consumers. Products repaired or replaced under this warranty may or may not have these changes.

Shipping (Only applies to packages shipped within the Continental U.S.)

1. Parts which prove defective within (90) days from the date of purchase, JL Marine Systems, Inc. will pay for the replacement product shipping and handling fees to and from the JL Marine Systems, Inc. manufacturing plant or some other place which JL Marine Systems, Inc. might designate.
2. Parts which prove defective after (90) days but before (12) months from the date of purchase will also be repaired or replaced free of charge, but there may be a shipping charge to JL Marine Systems, Inc. manufacturing plant or some other place which JL Marine Systems, Inc. might designate.
3. Parts which prove defective after (12) months will also be repaired or replaced free of charge, but there may be a shipping and handling charge to and from the JL Marine Systems, Inc. manufacturing plant or some other place which JL Marine Systems, Inc. might designate.

Parts

1. A **Stern bracket, Knuckle joint or U-channel**, which proves defective before sixty (60) months for Blade & Pro II and before thirty-six (36) months for Sportsman II models, will be repaired or replaced free of charge. In the case of replacement, parts of same (or equivalent) model will be used.
2. The **Hydraulic Pump Unit (HPU)** which proves defective within (24) months from date of purchase will be repaired or replaced free of charge. Pump damage due to incorrect hydraulic fluid, submersion or excessive exposure to water may void this warranty.
3. The **Powder Coated Finish** on the Blade, Pro II and Sportsman II models is covered for a period of six (6) months not to crack, chip or fade.
4. A **Cylinder, hydraulic hose, Dash Switch or Key-Fob** which proves defective within (24) months from date of purchase will be repaired or replaced free of charge. In the case of replacement, parts of same (or equivalent) model will be used.
5. **Spike** unconditional lifetime guarantee.
6. **This Warranty does not cover water damage in any way.**

THE WARRANTY CONTAINED HEREIN IS THE EXCLUSIVE WARRANTY MADE BY JL Marine Systems, Inc. AND THERE ARE NO OTHER WARRANTIES, EXPRESSED OR IMPLIED, INCLUDING A WARRANTY OF FITNESS FOR A PARTICULAR PURPOSE OR OF MERCHANTABILITY MADE WITH RESPECT TO SUCH ANCHORS. JL Marine Systems, Inc., IS NOT LIABLE FOR ANY INJURY OR MISHAPS SUSTAINED IN THE USE OF THIS PRODUCT. THE USER OF THIS PRODUCT ACKNOWLEDGES ASSUMED RISKS AND WAIVES ANY AND ALL CLAIMS AGAINST JL Marine Systems, Inc. AND ANY OF IT'S AGENTS.

This warranty applies under conditions of normal use. The warranty does not cover: 1) defects caused by improper assembly or disassembly; 2) defects occurring after purchase due to product modification, intentional damage, accident, misuse, abuse, negligence or exposure to corrosive elements; 3) cosmetic damage and 4) labor or assembly costs. Except as provided herein, JL Marine Systems, Inc. makes no express warranties, and any implied warranty, including without limitation any implied warranty of merchantability or fitness for a particular purpose, is limited in its duration to the duration of the written limited warranty set forth herein. Except as provided herein, JL Marine Systems, Inc. shall have no liability or responsibility to the purchaser or any other person or entity with respect to any liability, loss or damage caused or alleged to be caused directly or indirectly by use of the product, including, but not limited to, any incidental or consequential damages. Some states do not allow limitation on how long an implied warranty lasts or the exclusion of limitation of incidental or consequential damages, so the above limitation and exclusion may not apply to you. This warranty gives you specific legal rights. You may also have other rights which vary from state to state.

General Statement (for all devices)

Warning: Changes or modifications to this device not expressly approved by JL Marine Systems, Inc. could void the user's authority to operate the equipment.

FCC Specific Statement

NOTE: This equipment has been tested and found to comply with the limits for a Class B digital device, pursuant to Part 15 of the FCC Rules. These limits are designed to provide reasonable protection against harmful interference in a residential installation. This equipment generates, uses, and can radiate radio frequency energy and, if not installed and used in accordance with the instructions, may cause harmful interference to radio communications. However, there is no guarantee that interference will not occur in a particular installation. If this equipment does cause harmful interference to radio or television reception, which can be determined by turning the equipment off and on, the user is encouraged to try to correct the interference by one or more of the following measures:

- Reorient or relocate the receiving antenna.
- Increase the separation between the equipment and receiver
- Connect the equipment into an outlet on a circuit different from that to which the receiver is connected
- Consult the dealer or an experienced radio/TV technician for help

FCC Part 15.19 Warning Statement – (Required for all Part 15 devices) THIS DEVICE COMPLIES WITH PART 15 OF THE FCC RULES. OPERATION IS SUBJECT TO THE FOLLOWING TWO CONDITIONS: (1) THIS DEVICE MAY NOT CAUSE HARMFUL INTERFERENCE, AND (2) THIS DEVICE MUST ACCEPT ANY INTERFERENCE RECEIVED, INCLUDING INTERFERENCE THAT MAY CAUSE UNDESIRE OPERATION.

FCC/ISED RF Exposure

ENGLISH: This equipment complies with radiation exposure limits set forth for an uncontrolled environment. This equipment is in direct contact with the body of the user under normal operating conditions. The transmitter must not be co-located or operating in conjunction with any other antenna or transmitter.

FRENCH: Cet équipement est conforme aux limites d'exposition aux radiations dans un environnement non contrôlé. Cet équipement est en contact direct avec le corps de l'utilisateur dans des conditions de fonctionnement normales. Cet émetteur ne doit pas être co-localisé ou opérant en conjonction avec tout autre antenne ou transmetteur.

ENGLISH: This device complies with Industry Canada license-exempt RSS standard(s). Operation is subject to the following two conditions: (1) this device may not cause interference, and (2) this device must not accept any interference, including interference that may cause undesired operation of the device.

FRENCH: Le présent est conforme aux CNR d'Industrie Canada applicables aux appareils radio exempts de licence. L'exploitation est autorisée aux deux conditions suivantes: (1) l'appareil ne doit pas produire de brouillage, et (2) l'utilisateur de l'appareil doit accepter tout brouillage radioélectrique subi, même si le brouillage est susceptible d'en compromettre le fonctionnement.

CAUTION:

Do not use the Power-Pole shallow water anchor as your primary anchorage.
Never leave your boat unattended while anchored solely with the Power-Pole shallow water anchor.

US Pat No. 6,041,730

Need help? Contact our Technical Support Team at
1 + 813.689.9932 option 2



9010 Palm River Road, Tampa, Florida 33619
Phone 1+(813) 689-9932 Fax 1+(813) 689-8883
www.power-pole.com